

Clarinet Quarter-Tone Fingering Chart



1st Edition rev.1
2017

Jason Alder
www.jasonalder.com

Author's Note

This clarinet quarter-tone fingering chart developed as a continuation of my initial work of one for bass clarinet, which grew from my extensive playing of contemporary music and study of South-Indian Karnatic music. My focus had been primarily on bass clarinet, so the development of this chart for soprano clarinet didn't come to realization until some years later as my own need for it arose, occurring simultaneously with a decision to rework the initial bass clarinet chart into a second edition. The first edition for clarinet therefore follows the same conventions as the second edition bass clarinet fingering chart. This first revision revisits a few quarter-tone fingerings around the "break" after I discovered some better ones to use.

Jason Alder
London, 2017

Guide to the Fingering Chart

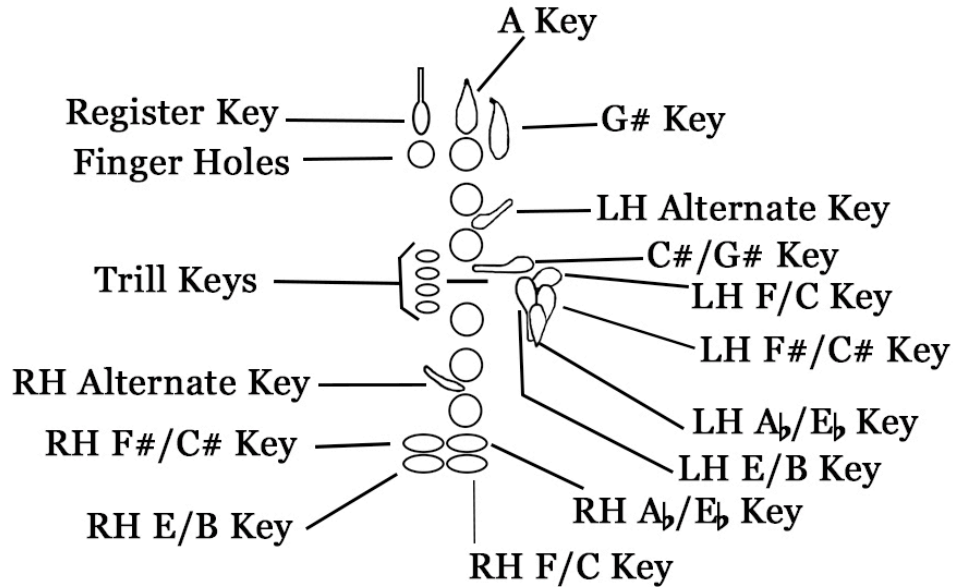

This fingering chart was made using a Buffet R13 clarinet, and thus the fingerings notated are based on the Boehm system. Because some differences may exist between different manufacturers, it is important to note how this system correlates to your own instrument. In some fingerings I have used the Left Hand A \flat /E \flat key, which not all instruments have. I've included this only when its use is an option, but have omitted the outline when it's not.

Many notes, particularly quarter-tones and altissimo notes, can have different fingerings. I have notated what I found to be best in tune for me, with less regard for ease and fluidity of playing. However, the intonation can differ between players and instruments. Use these fingerings as a guide, but it is important to check the tuning yourself and make alterations as needed.

This fingering chart follows the standard conventions of notation; white holes/keys indicates open/untouched, black indicates covered/depressed. Thus in the example to the right, the left hand finger holes are to be covered, the right hand fingers left open, and the C#/G# key depressed.



Holes which are only half colored indicates covering only half of the hole. Keys that have an X symbol across them indicate depressing the key halfway. Half-keying is imprecise, very difficult to do quickly, and often produces a less-than-desirable tone, but is sometimes necessary for tuning. This notation occurs primarily in the lowest range of the clarinet, as well as for some of the clarion register counterparts in the middle of the staff, where there are no other fingering options available for quarter-tones. These fingerings are also marked with ** to indicate that dropping the lip pressure and embouchure or slightly placing the tongue on the reed, either in addition to or instead of the half-keying, may be necessary to lower the pitch. It is best to experiment with these yourself with the aid of a tuning machine.



The accidental markings used in this chart are:

- ♭♭ - Three-quarters flat
- ♭ - Flat
- ♮ - Quarter flat
- ♮ - Natural
- ♯ - Quarter sharp
- ♯ - Sharp
- ♯♯ - Three-quarters sharp

Clarinet

Quarter-Tone Fingering Chart

Jason Alder

<p>E\flat F\flat</p>	<p>E\sharp F\natural **</p>	<p>E\sharp F\sharp</p>	<p>E\sharp F\sharp G\flat **</p>
<p>F\sharp G\flat</p>	<p>F\sharp G\natural **</p>	<p>G\natural</p>	<p>G\sharp A\flat</p>
<p>G\sharp A\flat</p>	<p>G\sharp A\natural</p>	<p>A\natural</p>	<p>A\sharp B\flat</p>
<p>A\sharp B\flat</p>	<p>A\sharp B\natural C\flat</p>	<p>B\natural C\flat</p>	<p>B\sharp C\natural</p>

** - May require extra manipulation with embouchure and/or tongue to lower pitch

Clarinet Quarter-Tone Fingering Chart

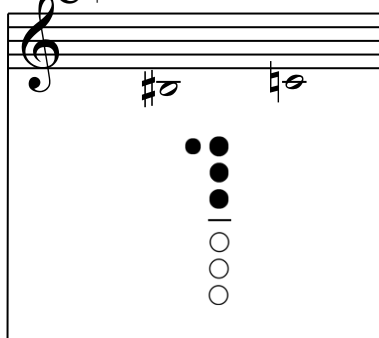
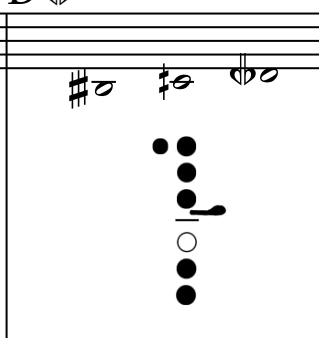
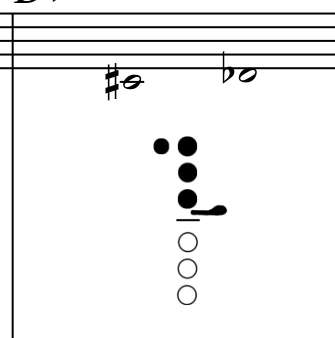
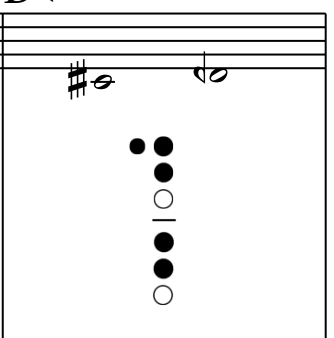
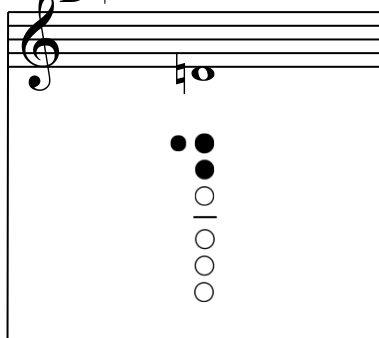
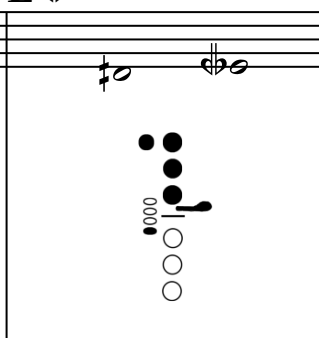
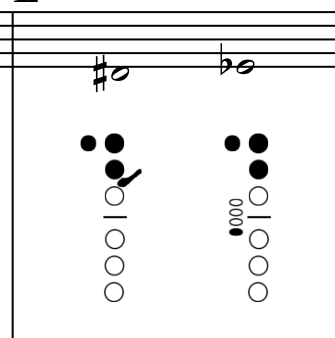
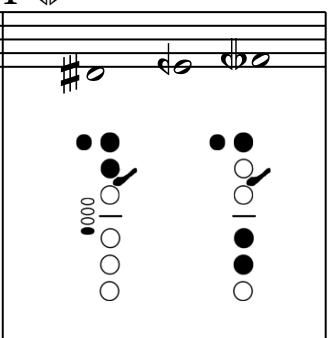
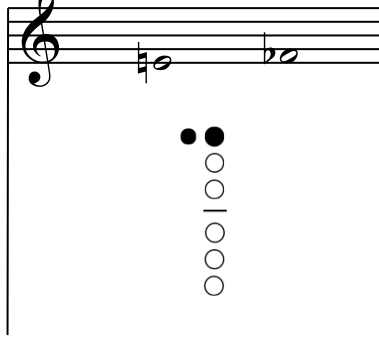
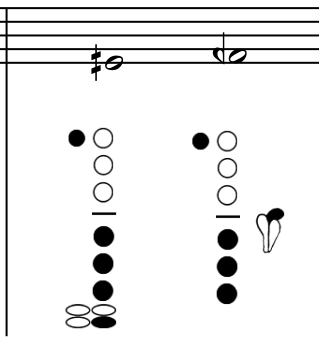
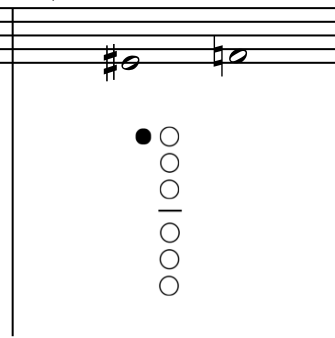
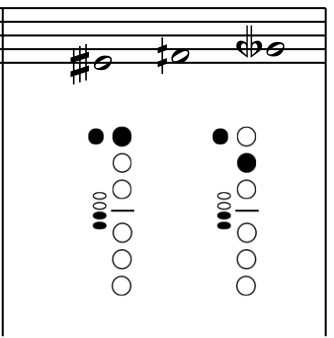
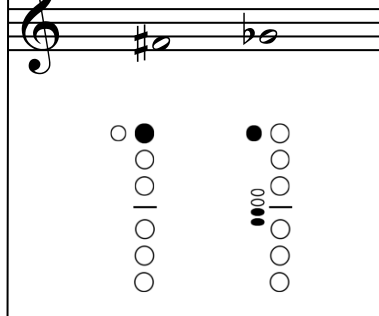
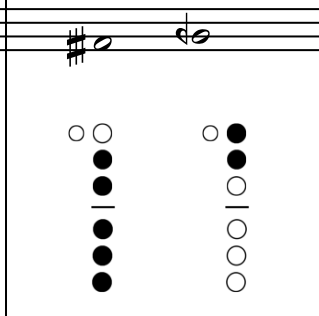
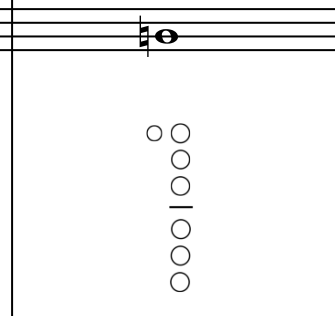
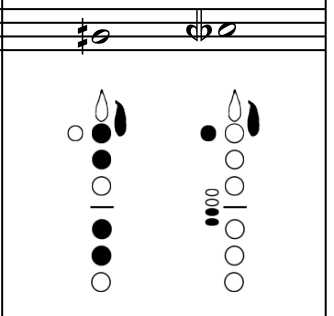
<p>B[♯] C[♯]</p> 	<p>B[♯] C[♯] D[♭]</p> 	<p>C[♯] D[♭]</p> 	<p>C[♯] D[♭]</p> 
<p>D[♯]</p> 	<p>D[♯] E[♭]</p> 	<p>D[♯] E[♭]</p> 	<p>D[♯] E[♭] F[♭]</p> 
<p>E[♯] F[♭]</p> 	<p>E[♯] F[♭]</p> 	<p>E[♯] F[♯]</p> 	<p>E[♯] F[♯] G[♭]</p> 
<p>F[♯] G[♭]</p> 	<p>F[♯] G[♯]</p> 	<p>G[♯]</p> 	<p>G[♯] A[♭]</p> 

Clarinet Quarter-Tone Fingering Chart

<p>G# A^b</p>	<p>G# A^b</p>	<p>A^b</p>	<p>A[#] B^b</p>

<p>A# B^b</p>	<p>A# B^b C^b</p>	<p>B^b C^b</p>	<p>B[#] C^b</p>

<p>B# C^b</p>	<p>B# C[#] D^b</p>	<p>C# D^b</p>	<p>C# D^b</p>

<p>D^b</p>	<p>D# E^b</p>	<p>D# E^b</p>	<p>D# E^b F^b</p>

Clarinet Quarter-Tone Fingering Chart

<p>E[♭] F[♭]</p>	<p>E[♯] F[♯]</p>	<p>E[♯] F[♯]</p>	<p>E[♯] F[♯] G[♭]</p>

<p>F[♯] G[♭]</p>	<p>F[♯] G[♯]</p>	<p>G[♯]</p>	<p>G[♯] A[♭]</p>

<p>G[♯] A[♭]</p>	<p>G[♯] A[♯]</p>	<p>A[♯]</p>	<p>A[♯] B[♭]</p>

<p>A[♯] B[♭]</p>	<p>A[♯] B[♯] C[♭]</p>	<p>B[♭] C[♭]</p>	<p>B[♯] C[♯]</p>

Clarinet Quarter-Tone Fingering Chart

<p>B[♯] C[♯] \sharp_2 \flat_2</p>	<p>B[♯] C[♯] D[♯] \sharp_2 \flat_2 \flat_2</p>	<p>C[♯] D[♯] \sharp_2 \flat_2</p>	<p>C[♯] D[♯] \sharp_2 \flat_2</p>

<p>D[♯] \flat_2</p>	<p>D[♯] E[♯] \sharp_2 \flat_2 \flat_2</p>	<p>D[♯] E[♯] \sharp_2 \flat_2</p>	<p>D[♯] E[♯] \sharp_2 \flat_2 \flat_2</p>

<p>E[♯] F[♯] \sharp_2 \flat_2</p>	<p>E[♯] F[♯] \sharp_2 \flat_2</p>	<p>E[♯] F[♯] \sharp_2 \flat_2</p>	<p>E[♯] F[♯] \sharp_2 \flat_2 \flat_2</p>

<p>F[♯] G[♯] \sharp_2 \flat_2</p>	<p>F[♯] G[♯] \sharp_2 \flat_2</p>	<p>F[♯] G[♯] \sharp_2 \flat_2</p>	<p>F[♯] G[♯] \sharp_2 \flat_2 \flat_2</p>

Clarinet Quarter-Tone Fingering Chart

<p>G# #\flat $\flat$$\flat$</p> <p>A$\flat$ #\flat $\flat$$\flat$</p>	<p>G# #\flat $\flat$$\flat$</p> <p>A$\flat$ #\flat $\flat$$\flat$</p>	<p>A\sharp $\sharp$$\flat$</p> <p>A$\sharp$ $\sharp$$\flat$</p>	<p>A\sharp #\flat $\flat$$\flat$</p> <p>B$\flat$ #\flat $\flat$$\flat$</p>

<p>A# #\flat $\flat$$\flat$</p> <p>B$\flat$ #\flat $\flat$$\flat$</p>	<p>A\sharp #\flat $\flat$$\flat$ $\flat$$\flat$</p> <p>B$\flat$ #\flat $\flat$$\flat$ $\flat$$\flat$</p> <p>C$\flat$ #\flat $\flat$$\flat$ $\flat$$\flat$</p>	<p>B\sharp $\sharp$$\flat$ $\flat$$\flat$</p> <p>B$\sharp$ $\sharp$$\flat$ $\flat$$\flat$</p>	<p>B\sharp #\flat $\flat$$\flat$</p> <p>C$\flat$ #\flat $\flat$$\flat$ $\flat$$\flat$</p>

<p>B# #\flat $\sharp$$\flat$</p> <p>C$\sharp$ #\flat $\sharp$$\flat$</p>	<p>B\sharp #\flat $\sharp$$\flat$ $\sharp$$\flat$ $\flat$$\flat$</p> <p>C$\sharp$ #\flat $\sharp$$\flat$ $\sharp$$\flat$ $\flat$$\flat$</p> <p>D$\flat$ #\flat $\sharp$$\flat$ $\sharp$$\flat$ $\flat$$\flat$</p>	<p>C# #\flat $\flat$$\flat$</p> <p>C# #$\flat$ $\flat$$\flat$</p>	<p>C\sharp #\flat $\flat$$\flat$</p> <p>D$\flat$ #\flat $\sharp$$\flat$ $\flat$$\flat$</p>

<p>D\sharp $\sharp$$\flat$</p> <p>D$\sharp$ $\sharp$$\flat$</p>	<p>D\sharp #\flat $\flat$$\flat$</p> <p>E$\flat$ #\flat $\flat$$\flat$ $\flat$$\flat$</p>	<p>D\sharp #\flat $\flat$$\flat$</p> <p>D$\sharp$ #\flat $\flat$$\flat$</p>	<p>D\sharp #\flat $\flat$$\flat$ $\flat$$\flat$</p> <p>E$\flat$ #\flat $\flat$$\flat$ $\flat$$\flat$</p>